

**VARIABLE ORIFICE  
BALANCING VALVE**

**cim 3739B / G**

**PN 16**

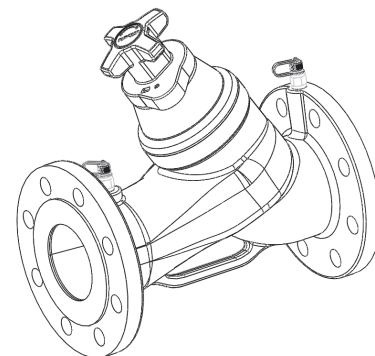

**Main features:**

Cim 3739B and 3739G are used for balancing the flow in cooling, heating and domestic water systems.

They are a combined manual presetting valve with following features:

- Variable measurement orifice;
- Supplied with 2 pcs. of measuring nipples for needles;
- Handwheel with shut-off function and clear 360° reading;
- Digital scale with lock function;
- High measuring accuracy.

It is supplied with flanged ends (Cim 3739B) or grooved end (Cim 3739G).

It is made of EN-JL 1040 cast iron.

These articles are made in compliance with the quality management requirements of ISO 9001:2008 standard.

All articles are tested according to EN 12266-1:2003 standard.

They can be used in a wide variety of sectors: heating, air conditioning, water, sanitary systems and generally with any non corrosive liquid.

**Technical data:**

Max. static working pressure	16 bar
Max. flow temperature	120 °C
Min. temperature	-10°C
Fluids:	Water and Glycol
Material of parts in contact with water:	Valve body; Spindle; Cone, etc.
Materials:	Cast Iron (EN-JL 1040)
O-rings:	EPDM
Flanges:	ISO 7005-2 (PN 16)
Face to face dimension standard:	EN 558, S 1

**Approved by\*:**



\*Cim 3739B

Rev. 0 del 11/2013

## TECHNICAL DATA SHEET

### Models:

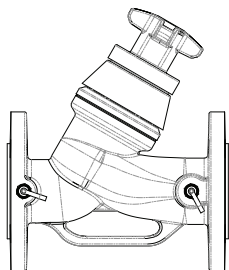

Cim 3739B - Balancing valve - Variable orifice - PN 16 - Cast Iron - Drilled flange			
DN	Material	Kv - Kvs	Technical Code
40	Cast Iron EN-JL 1040	10.09 ÷ 26.15	DS00358040
50		6.55 ÷ 47.50	DS00358050
65		6.99 ÷ 79.71	DS00358065
80		14.77 ÷ 116.81	DS00358080
100		21.03 ÷ 196.78	DS00358100
125		69.87 ÷ 360.05	DS00358125
150		35.10 ÷ 387.84	DS00358150
200		108.67 ÷ 724.81	DS00358200
250		153.99 ÷ 865.96	DS00358250
300		256.83 ÷ 1474.60	DS00358300

Cim 3739BDP - Balancing valve - Variable orifice - PN 16 - Cast Iron - Drilled flange - Capillary fitting			
DN	Material	Kv - Kvs	Technical Code
40	Cast Iron EN-JL 1040	10.09 ÷ 26.15	DS00568040
50		6.55 ÷ 47.50	DS00568050
65		6.99 ÷ 79.71	DS00568065
80		14.77 ÷ 116.81	DS00568080
100		21.03 ÷ 196.78	DS00568100
125		69.87 ÷ 360.05	DS00568125
150		35.10 ÷ 387.84	DS00568150
200		108.67 ÷ 724.81	DS00568200
250		153.99 ÷ 865.96	DS00568250
300		256.83 ÷ 1474.60	DS00568300

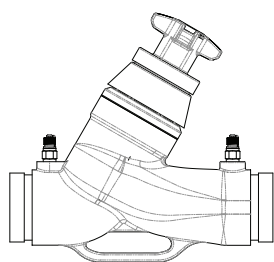

Cim 3739G- Balancing valve - Variable orifice - PN 16 - Cast Iron - Grooved ends			
DN	Material	Kv - Kvs	Technical Code
40	Cast Iron EN-JL 1040	10.09 ÷ 26.15	DS00398040
50		6.55 ÷ 47.50	DS00398050
65		6.99 ÷ 79.71	DS00398065
65A		6.99 ÷ 79.71	DS00398066
80		14.77 ÷ 116.81	DS00398080
100		21.03 ÷ 196.78	DS00398100
125		69.87 ÷ 360.05	DS00398125
125A		69.87 ÷ 360.05	DS00398126
150		35.10 ÷ 387.84	DS00398150
150A		35.10 ÷ 387.84	DS00398151
200		108.67 ÷ 724.81	DS00398200
250		153.99 ÷ 865.96	DS00398250
300		256.83 ÷ 1474.60	DS00398300

TECHNICAL DATA SHEET

**Cross section:**

1. Valve body
2. Disc
3. Stem fixing nut
4. Stem
5. Bonnet
6. Stem O-ring
7. Bonnet O-ring
8. Centering part
9. Stem moving nut
10. Centering nut
11. Test point
12. Handwheel set
13. Gasket

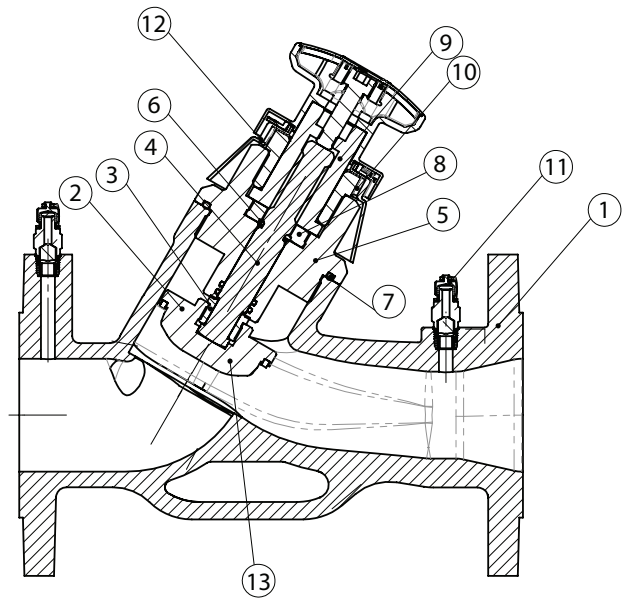

**Installation procedure:**

Remove the protecting covers of the flanges if applicable. Before installation of CIM 3739B, check that inside the valve and the pipes, there are no foreign matters which might damage the tightness of the valve.

When installing the valve, please make sure to have a pipe length 5 times the DN upstream the valve and 2 times the DN downstream, and pay attention to the arrow direction casted on the valve body, which shall be the same as the flow one.

The valve can be installed with handle in any position. If fluid is not sure to be cleaned, it is advisable to have the handle upwards.

CIM 3739B shall be installed to the flanges of the pipe perfectly aligned with its flanges, by assuring that coupled parts will not suffer any stress. The valve shall not be used as anchor for hanging pipes, rather it is the pipe that shall support the valve itself. Make sure to true up the tightening gaskets of the flanges before tightening the bolts.

Pay attention to any welding procedure carried out in the installation, for this could cause high temperatures exceeding the working limits of the valve. Pipes should be equipped with thermal expansion joint.

**TECHNICAL DATA SHEET**

**Regulating:**

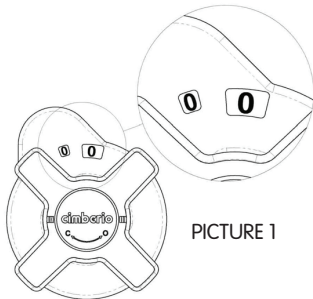

PICTURE 1

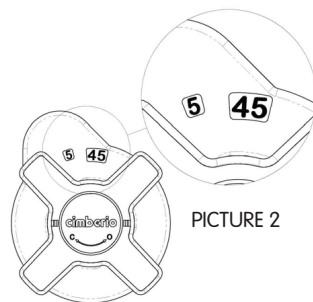

PICTURE 2

To close the valve, rotate clockwise the handle until the stop. The position of the obturator is given by the numbers shown in the two windows of the handle. The left window shows the complete turns, while the right one shows the hundredths of turn at interval of 0,05 (see picture 1). When the valve is completely closed, the two windows show a 0,0 value.

$\Delta p$  and relevant flow rate values can be read through the differential manometer Cim 726. This interfaces with the balancing valve through two sensors inserted in the binder points placed at the two ends of the valve, near the flanges. Looking at the data showed in the herewith attached diagrams, it is possible to regulate the flow by rotating the handle anti-clockwise until the required flow rate is reached (f.i.5, 45 picture 2).

When the regulating position is reached, take the cover "a" of the handle off (picture 4) by a screwdriver.

Rotate clockwise the screw "b" (picture 3) placed under the cover by an Allen Key 8 mm. until the stop. In this way, the valve can be closed and opened again up to the regulating value fixed previously.

In order to prevent the removal of the cover after the balancing process, lock the cover by a metallic wire inserted in the proper hole "c" (picture 4) and then seal it. In this way the regulating screw of the total opening is no more accessible.

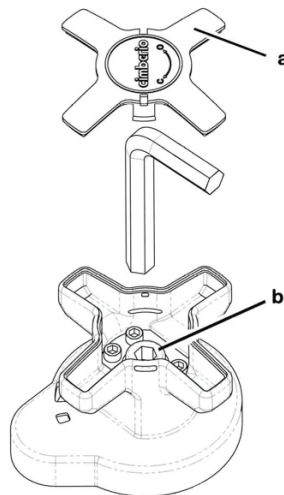

PICTURE 3

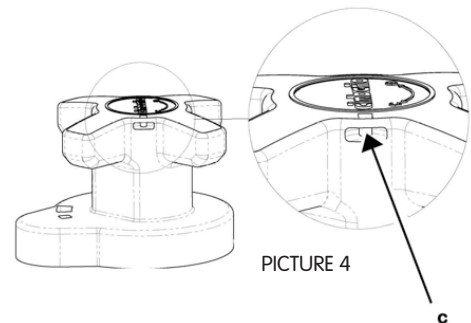

PICTURE 4

**Sizing:**

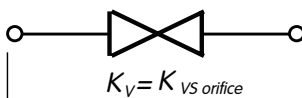

Kvs orifice - Kv across orifices  
Kv - Kv across valve

Relative density	
Fluid	r
Water	1.000
Water and glycol 10%	1.012
Water and glycol 20%	1.028
Water and glycol 30%	1.040
Water and glycol 40%	1.054
Water and glycol 50%	1.067

**FLOW COEFFICIENT**

Kv, in metric system represents the flow in m<sup>3</sup>/h of water at the temperature of 15.5°C (density =998 kg/m<sup>3</sup>) which causes a pressure drop of 1 bar. In the USA flow coefficient is called Cv (Kv = 0.865 Cv).

$$Kv = \frac{Q}{\sqrt{\Delta p}}$$

It is possible to calculate the pressure drop across a valve with a generic flow rate and fluid:

$$\Delta p = r \cdot \left( \frac{Q}{kv} \right)^2$$

where:

r is the relative density, Q is the flow rate in m<sup>3</sup>/h.

# TECHNICAL DATA SHEET

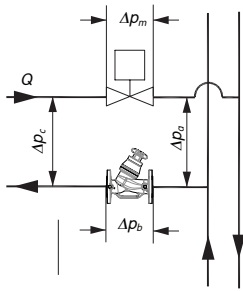

$$\Delta p_o = \Delta p_b + \Delta p_c + \Delta p_m$$

- $\Delta p_b$  Pressure drop across Cim 3739B
- $\Delta p_m$  Pressure drop across the control valve
- $\Delta p_c$  Necessary pressure for the circuit
- $\Delta p_o$  Available pressure for the riser

### SUGGESTED VALUES AND TIPS:

- Pressure drop across the valve:  
Max = 50 kPa
- Pressure drop across the binders:  
Max = 50 kPa  
Min = 1 kPa
- Velocities in the pipeline:  
Max = 3 m/s  
Min = 0.75 m/s

For the preliminary sizings where the value of pressure drop across the valve is not known, use a value of 10 kPa.

### EXAMPLE

It is required to balance the circuit in the figure, the given data are:

- Necessary pressure for the circuit:  $\Delta p_c = 13 \text{ kPa}$ ;
- Available pressure for the riser:  $\Delta p_o = 35 \text{ kPa}$ ;
- Pressure drop across the control valve:  $\Delta p_m = 10 \text{ kPa}$ ;
- Flow rate:  $Q = 30 \text{ m}^3/\text{h} = 8.33 \text{ l/s}$ .

The required differential pressure across the balancing valve can be calculated using the following relation:

$$\Delta p_b = \Delta p_o - \Delta p_m - \Delta p_c = 35 - 10 - 13 = 12 \text{ kPa} = 0,12 \text{ bar}$$

the required Kv is:

$$Kv = Q \cdot \sqrt{\frac{r}{\Delta p_b}} = 30 \cdot \sqrt{\frac{1}{12}} = 86.6$$

Using the attached tables to this datasheet, it is possible to find the following available valves with the relative position of the handle:

- Cim 3739B DN 80 --> Preset: 5.4 (Kv=86.40);
- Cim 3739B DN 100 --> Preset: 4.1 (Kv=85.06);
- Cim 3739B DN 125 --> Preset: 1.3 (Kv=85.93);
- Cim 3739B DN 150 --> Preset: 2.8 (Kv=88.38);

The four selected models are comparable. As a general rule, it is better to choose the valve with the smallest diameter, in this way the valve will be quite opened and there will be no problem with noises and cavitations.

Measuring the pressure drop across the binders of the Cim 3739B DN 80 (Preset 5.4), the operator will find this value:

$$\Delta p_{bin} = r \cdot \left(\frac{Q}{Kvs}\right)^2 = 1 \cdot \left(\frac{30}{86.4}\right)^2 = 0.12 \text{ bar} = 12 \text{ kPa}$$

**N.B. The Kvs value is equal to the Kv of the valve and the measured pressure drop across the binders is the pressure drop across the valve too.**

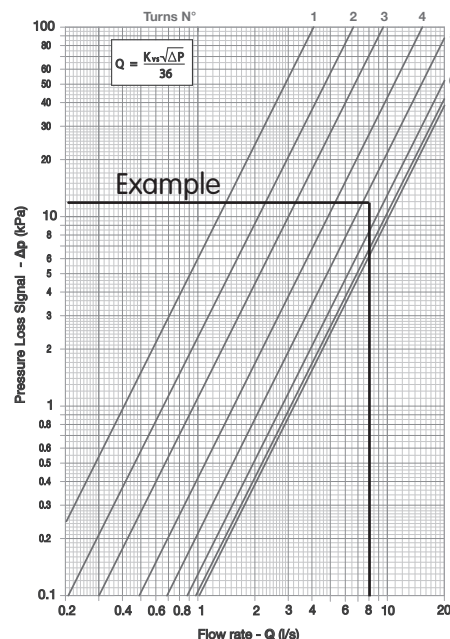

TECHNICAL DATA SHEET

Measurement conversion chart

Pressure

FROM	MULTIPLY BY	TO OBTAIN
Pa, Pascal	0,001	kPa, kiloPascal
Pa, Pascal	0,000001	MPa, Mega Pascal
Pa, Pascal	0,00001	bar
Pa, Pascal	0,00010972	m <sub>H2O</sub> , metres of water
Pa, Pascal	0,000145038	psi, pound per square inch
bar	1,01325	atm, atmosphere
bar	0,980665	Kg/cm <sup>2</sup> , kilograms per square centimetre
bar	10,1972	m <sub>H2O</sub> , metres of water
bar	14,5038	psi, pound per square inch
atm, atmosphere	1,03323	Kg/cm <sup>2</sup> , kilograms per square centimetre
atm, atmosphere	10,3323	m <sub>H2O</sub> , metres of water
atm, atmosphere	14,6959	psi, pound per square inch
Kg/cm <sup>2</sup>	10	m <sub>H2O</sub> , metres of water
Kg/cm <sup>2</sup>	14,2233	psi, pound per square inch
m <sub>H2O</sub>	1,42233	psi, pound per square inch

← TO OBTAIN      DIVIDE BY      FROM →

Length, Area, Volume, Density

FROM	MULTIPLY BY	TO OBTAIN
inches	0,0254	m, metres
inches	2,54	cm, centimetres
feet	0,3048	m, metres
feet	30,48	cm, centimetres
yards	0,9144	m, metres
square inches	0,00064516	m <sup>2</sup> , metri quadrati
square feet	0,09290304	m <sup>2</sup> , square metres
square inches	6,4516	cm <sup>2</sup> , square centimetres
square feet	929,0304	cm <sup>2</sup> , square centimetres
square yards	0,8361274	m <sup>2</sup> , square metres
l, litres	0,001	m <sup>3</sup> , cubic metres
gallons	0,003789412	m <sup>3</sup> , cubic metres
cubic yards	0,7645549	m <sup>3</sup> , cubic metres
cubic feet	0,02831685	m <sup>3</sup> , cubic metres
cubic inches	0,0000164	m <sup>3</sup> , cubic metres
cubic inches	16,38706	cm <sup>3</sup> , cubic centimetres
cubic feet	28,31685	l, litres
gallons	3,785412	l, litres

← TO OBTAIN      DIVIDE BY      FROM →

Pressure-temperature ratings

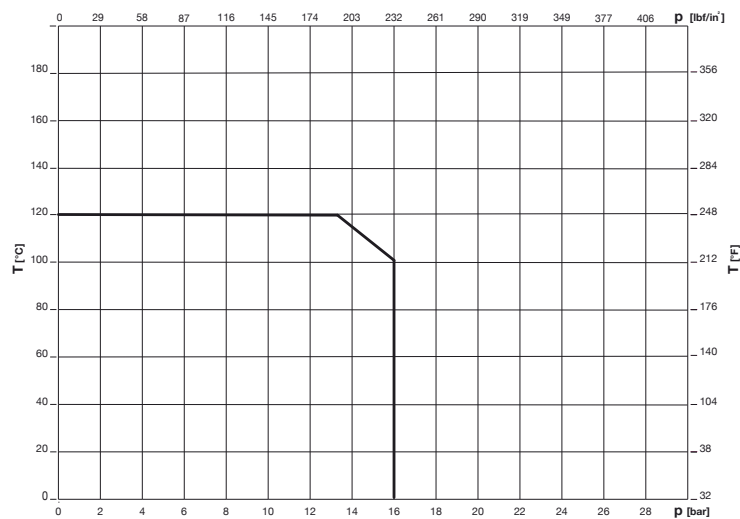

TECHNICAL DATA SHEET

**Kv Values - DN 40**

Cim 3739B  
Cim 3739BDP  
Cim 3739G

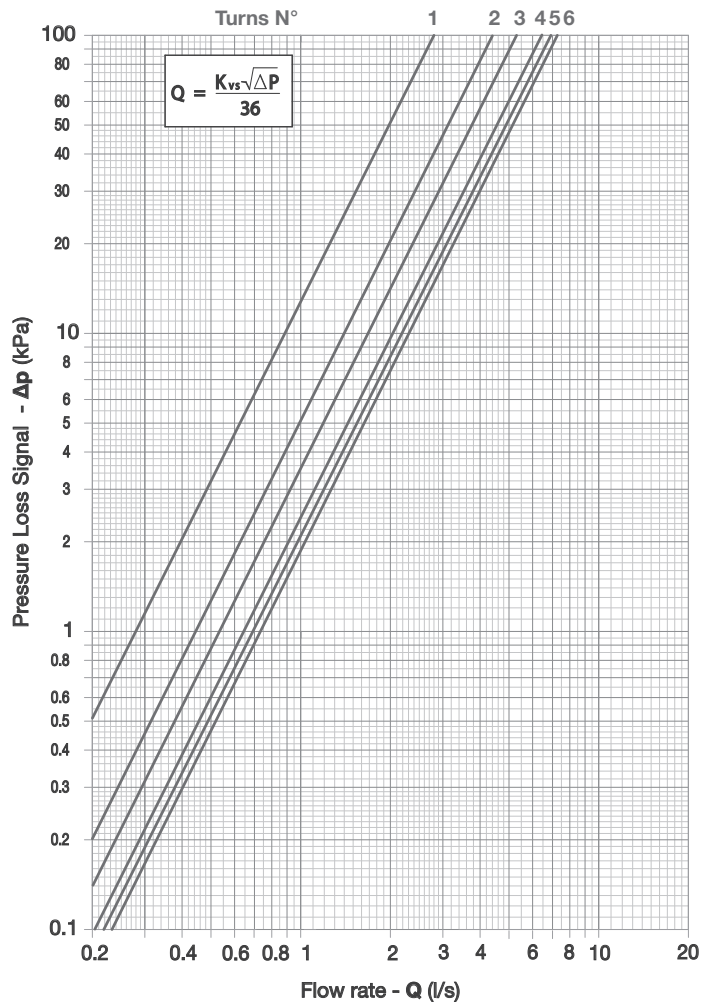
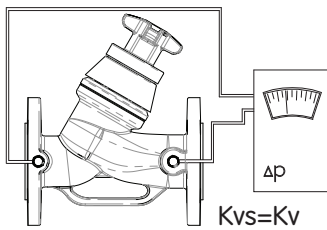

**Kv-Kvs (Flow rate in m<sup>3</sup>/h @ 1 bar pressure drop)**

Full turn	Tenths of turn									
	0.0	0.1	0.2	0.3	0.4	0.5	0.6	0.7	0.8	0.9
1	10.09	10.69	11.28	11.88	12.47	13.07	13.66	14.26	14.85	15.45
2	16.04	16.35	16.66	16.97	17.28	17.59	17.90	18.21	18.52	18.83
3	19.14	19.53	19.92	20.31	20.70	21.09	21.47	21.86	22.25	22.64
4	23.03	23.22	23.41	23.60	23.79	23.99	24.18	24.37	24.56	24.75
5	24.94	25.06	25.18	25.30	25.42	25.55	25.67	25.79	25.91	26.03
6	26.15									
7										
8										
9										
10										
11										
12										
13										
14										

## TECHNICAL DATA SHEET

### Kv Values - DN 50

Cim 3739B  
Cim 3739BDP  
Cim 3739G

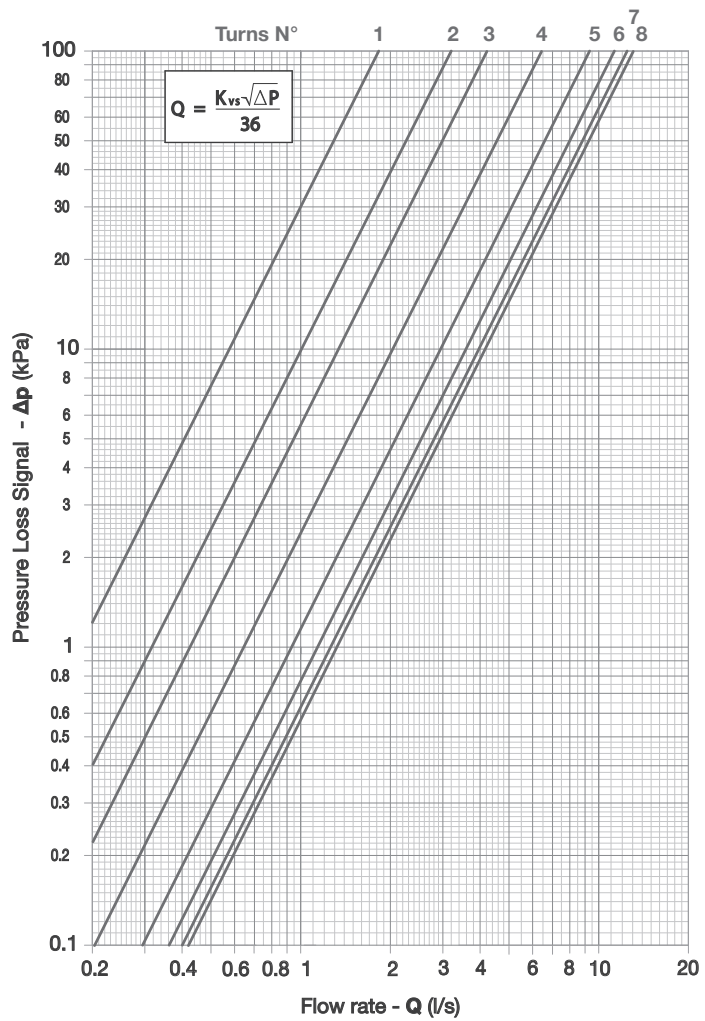
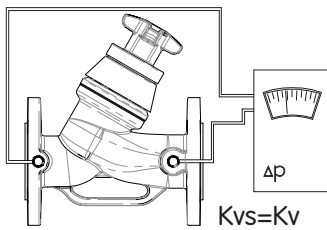

**Kv-Kvs (Flow rate in m<sup>3</sup>/h @ 1 bar pressure drop)**

Full turn	Tenths of turn									
	0.0	0.1	0.2	0.3	0.4	0.5	0.6	0.7	0.8	0.9
1	6.55	7.05	7.55	8.05	8.55	9.06	9.56	10.06	10.56	11.06
2	11.56	11.94	12.31	12.69	13.06	13.44	13.82	14.19	14.57	14.94
3	15.32	16.10	16.88	17.66	18.44	19.22	19.99	20.77	21.55	22.33
4	23.11	24.12	25.21	26.26	27.31	28.36	29.40	30.45	31.50	32.55
5	33.60	34.40	35.20	36.01	36.81	37.61	38.41	39.21	40.02	40.82
6	41.62	42.04	42.46	42.87	43.29	43.71	44.13	44.55	44.96	45.38
7	45.80	45.97	46.14	46.31	46.48	46.65	46.82	46.99	47.16	47.33
8	47.50									
9										
10										
11										
12										
13										
14										



TECHNICAL DATA SHEET

**Kv Values - DN 65 & 65A**

Cim 3739B  
Cim 3739BDP  
Cim 3739G

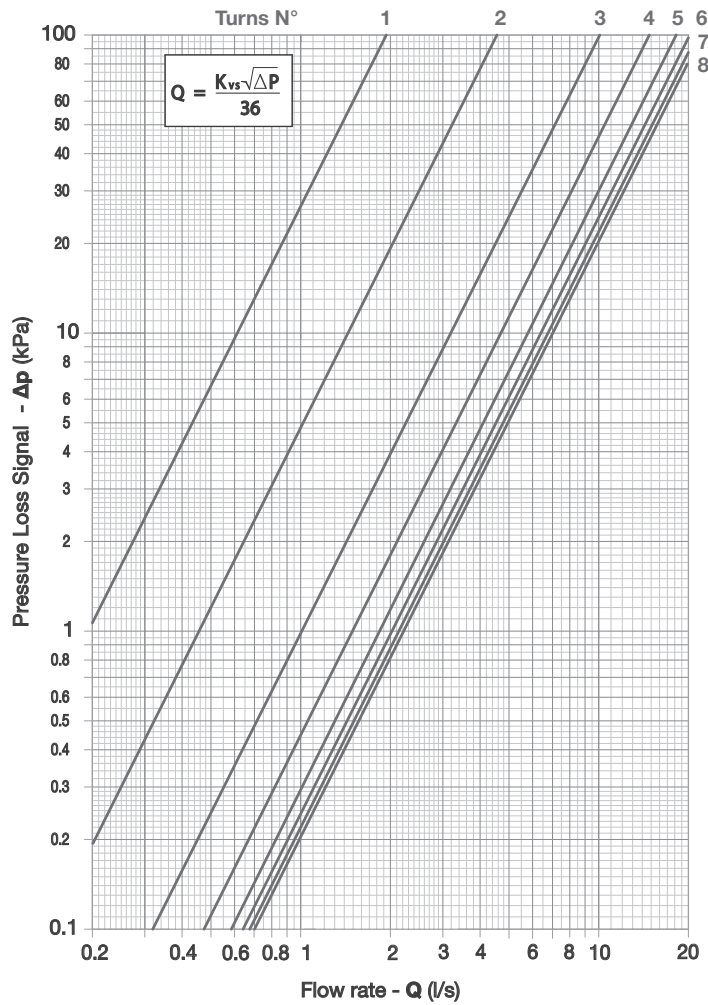
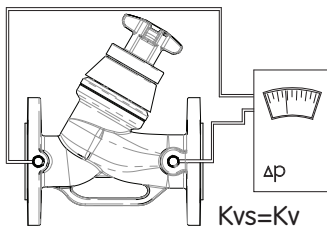

**Kv-Kvs (Flow rate in m<sup>3</sup>/h @ 1 bar pressure drop)**

Full turn	Tenths of turn									
	0.0	0.1	0.2	0.3	0.4	0.5	0.6	0.7	0.8	0.9
1	6.99	7.94	8.89	9.84	10.79	11.75	12.70	13.65	14.60	15.55
2	16.50	18.45	20.40	22.36	24.31	26.26	28.21	30.16	32.12	34.07
3	36.02	37.74	39.45	41.17	42.89	44.61	46.32	48.04	49.76	51.47
4	53.19	54.51	55.84	57.16	58.49	59.81	61.13	62.46	63.78	65.11
5	66.43	67.13	67.83	68.53	69.23	69.93	70.63	71.33	72.03	72.73
6	73.43	73.79	74.14	74.50	74.85	75.21	75.57	75.92	76.28	76.63
7	76.99	77.26	77.53	77.81	78.08	78.35	78.62	78.89	79.17	79.44
8	79.71									
9										
10										
11										
12										
13										
14										

TECHNICAL DATA SHEET

**Kv Values - DN 80**

Cim 3739B  
Cim 3739BDP  
Cim 3739G

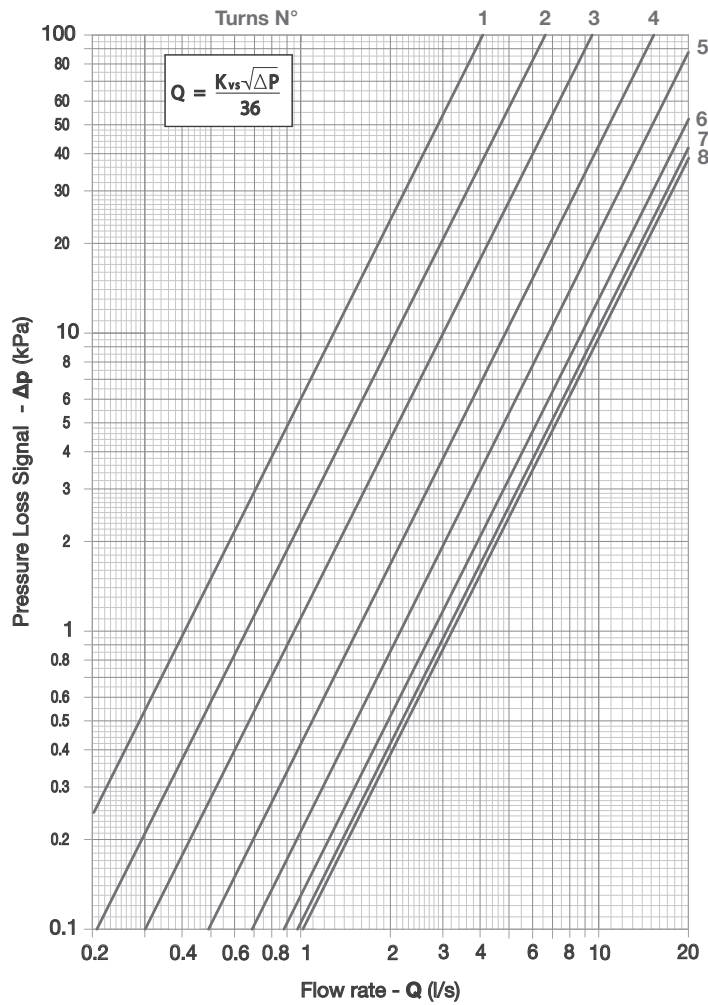
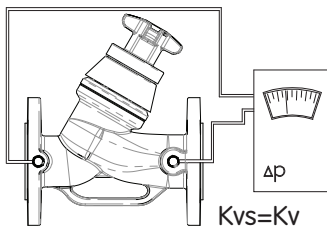

Kv-Kvs (Flow rate in m <sup>3</sup> /h @ 1 bar pressure drop)										
Full turn	Tenths of turn									
	0.0	0.1	0.2	0.3	0.4	0.5	0.6	0.7	0.8	0.9
1	14.77	15.64	16.51	17.37	18.24	19.11	19.98	20.85	21.71	22.58
2	23.45	24.54	25.63	26.73	27.82	28.91	30.00	31.09	32.19	33.28
3	34.37	36.45	38.52	40.60	42.68	44.76	46.83	48.91	50.99	53.06
4	55.14	57.40	59.66	61.91	64.17	66.43	68.69	70.95	73.20	75.46
5	77.72	79.89	82.06	84.23	86.40	88.58	90.75	92.92	95.06	97.26
6	99.43	100.73	102.03	103.33	104.63	105.93	107.23	108.53	109.83	111.13
7	112.43	112.87	113.31	113.74	114.18	114.62	115.06	115.50	115.93	116.37
8	116.81									
9										
10										
11										
12										
13										
14										

**TECHNICAL DATA SHEET**

**Kv Values - DN 100**

Cim 3739B  
 Cim 3739BDP  
 Cim 3739G

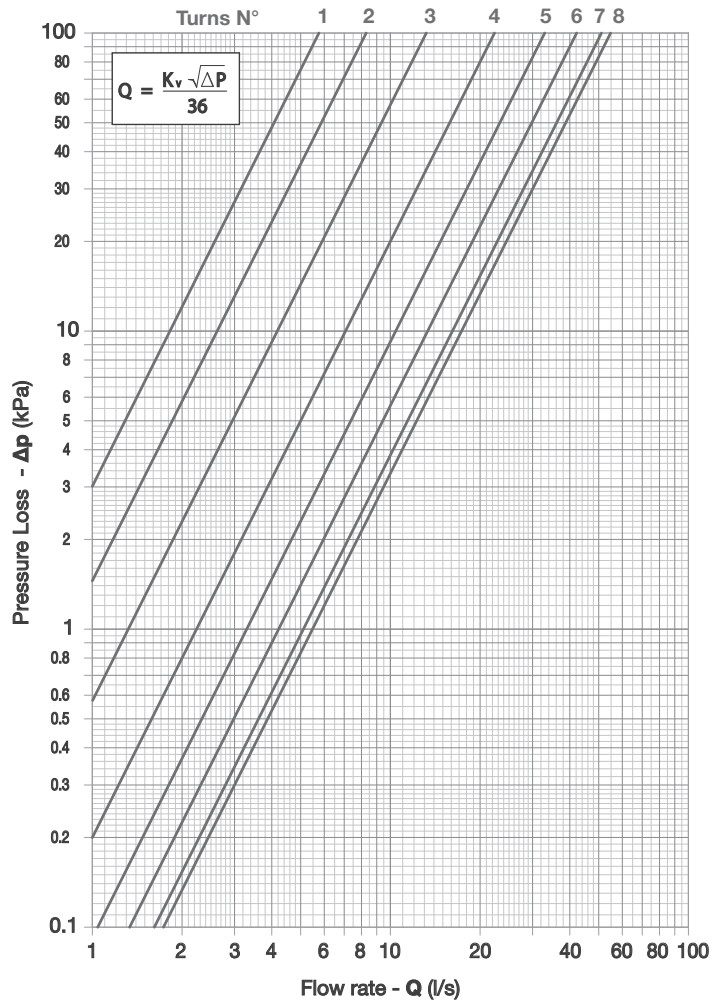
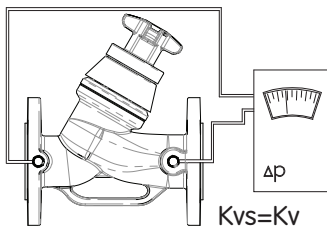

Kv-Kvs (Flow rate in m <sup>3</sup> /h @ 1 bar pressure drop)										
Full turn	Tenths of turn									
	0.0	0.1	0.2	0.3	0.4	0.5	0.6	0.7	0.8	0.9
1	21.03	21.93	22.82	23.72	24.61	25.51	26.40	27.30	28.19	29.09
2	29.98	31.73	33.48	35.23	36.98	38.74	40.49	42.24	43.99	45.74
3	47.49	50.88	54.27	57.66	61.05	64.45	67.84	71.23	74.62	78.01
4	81.40	85.06	88.71	92.37	96.03	99.69	103.34	107.00	110.66	114.31
5	117.97	121.43	124.89	128.35	131.81	135.27	138.72	142.18	145.64	149.10
6	152.56	155.63	158.69	161.76	164.83	167.90	170.96	174.03	177.10	180.16
7	183.23	184.59	185.94	187.30	188.65	190.01	191.36	192.72	194.07	195.43
8	196.78									
9										
10										
11										
12										
13										
14										

**TECHNICAL DATA SHEET**

**Kv Values - DN 125 & 125A**

Cim 3739B  
Cim 3739BDP  
Cim 3739G

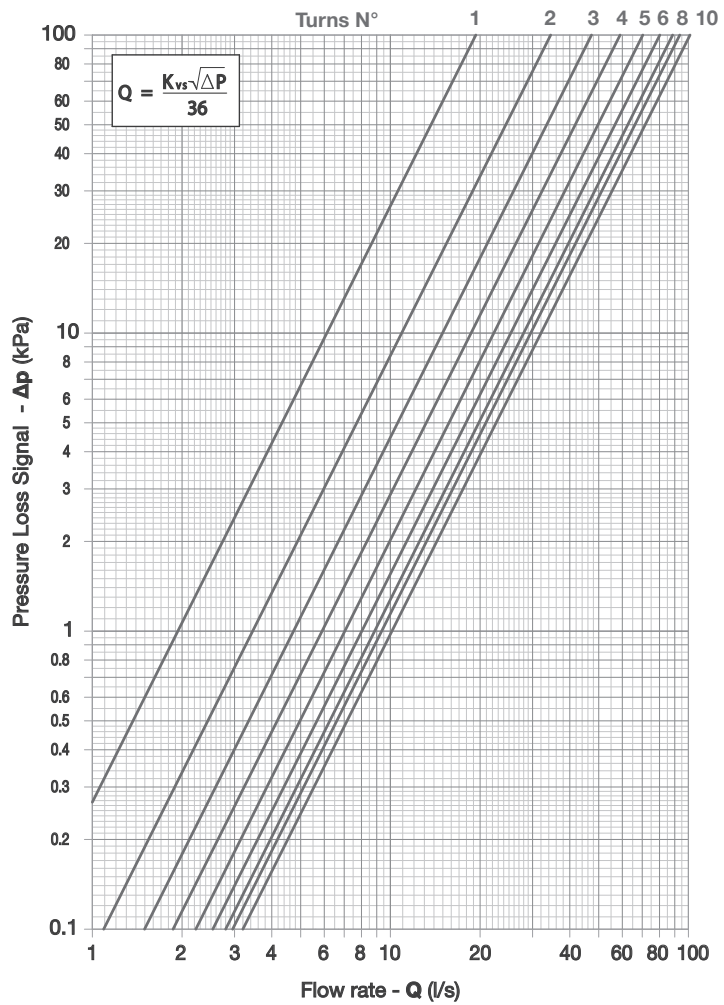
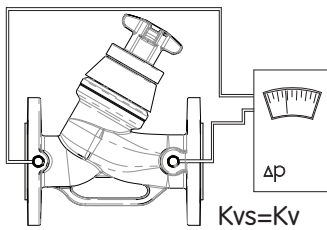

Kv-Kvs (Flow rate in m <sup>3</sup> /h @ 1 bar pressure drop)										
Full turn	Tenths of turn									
	0.0	0.1	0.2	0.3	0.4	0.5	0.6	0.7	0.8	0.9
1	69.87	75.22	80.58	85.93	91.28	96.64	101.99	107.34	112.69	118.05
2	123.40	127.97	132.53	137.10	141.66	146.23	150.79	155.36	159.92	164.49
3	169.05	173.37	177.70	182.02	186.35	190.67	194.99	199.32	203.64	207.97
4	212.29	216.31	220.34	224.36	228.38	232.41	236.43	240.45	244.47	248.50
5	252.52	256.30	260.08	263.86	267.64	271.42	275.19	278.97	282.75	286.53
6	290.31	292.96	295.61	298.26	300.91	303.57	306.22	308.87	311.52	314.17
7	316.82	318.65	320.48	322.31	324.14	325.97	327.80	329.63	331.46	333.29
8	335.12	337.27	339.42	341.58	343.73	345.88	348.03	350.18	352.34	354.49
9	356.64	356.98	357.32	357.66	358.00	358.35	358.69	359.03	359.37	359.71
10	360.05									
11										
12										
13										
14										

TECHNICAL DATA SHEET

**Kv Values - DN 150 & 150A**

Cim 3739B  
Cim 3739BDP  
Cim 3739G

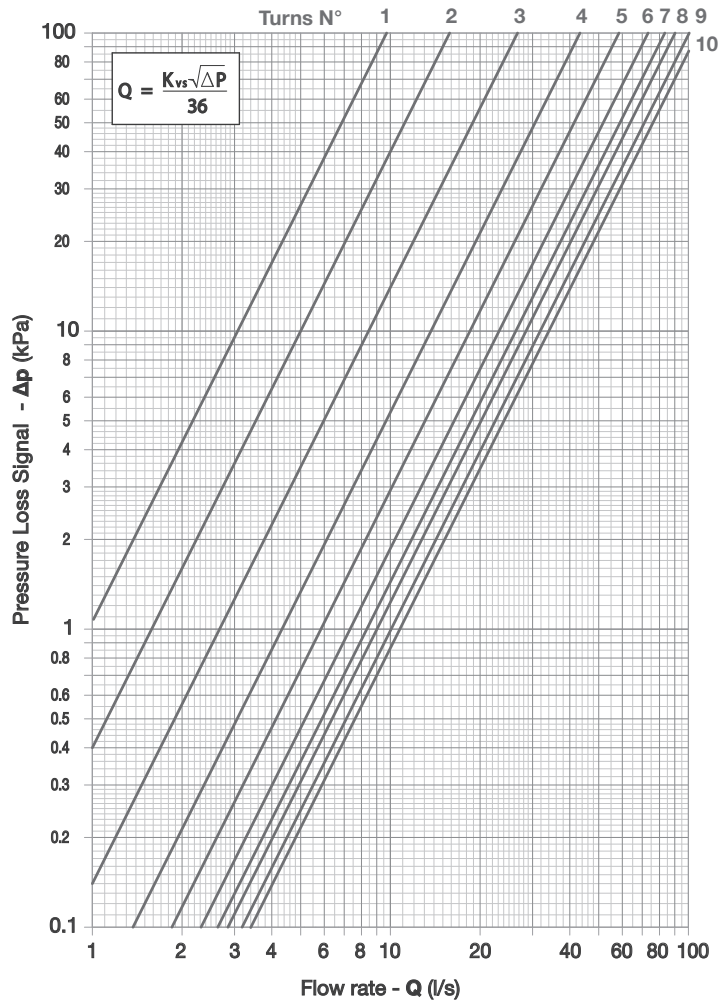
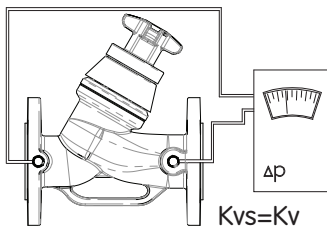

Kv-Kvs (Flow rate in m <sup>3</sup> /h @ 1 bar pressure drop)										
Full turn	Tenths of turn									
	0.0	0.1	0.2	0.3	0.4	0.5	0.6	0.7	0.8	0.9
1	35.10	37.26	39.42	41.58	43.74	45.90	48.06	50.22	52.38	54.54
2	56.70	60.66	64.62	68.58	72.54	76.50	80.46	84.42	88.38	92.34
3	96.30	102.23	108.16	114.09	120.02	125.95	131.88	137.81	143.74	149.67
4	155.60	161.07	166.54	172.01	177.48	182.95	188.42	193.89	199.36	204.83
5	210.30	215.60	220.90	226.20	231.50	236.80	242.10	247.40	252.70	258.00
6	263.30	266.98	270.66	274.35	278.03	281.71	285.39	289.07	292.76	296.44
7	300.12	302.54	304.97	307.39	309.82	312.24	314.66	317.09	319.51	321.94
8	324.36	327.58	330.80	334.02	337.24	340.46	343.67	346.89	350.11	353.33
9	356.55	359.68	362.81	365.94	369.07	372.20	375.32	378.45	381.58	384.71
10	387.84									
11										
12										
13										
14										

**TECHNICAL DATA SHEET**

**Kv Values - DN 200**

Cim 3739B  
 Cim 3739BDP  
 Cim 3739G

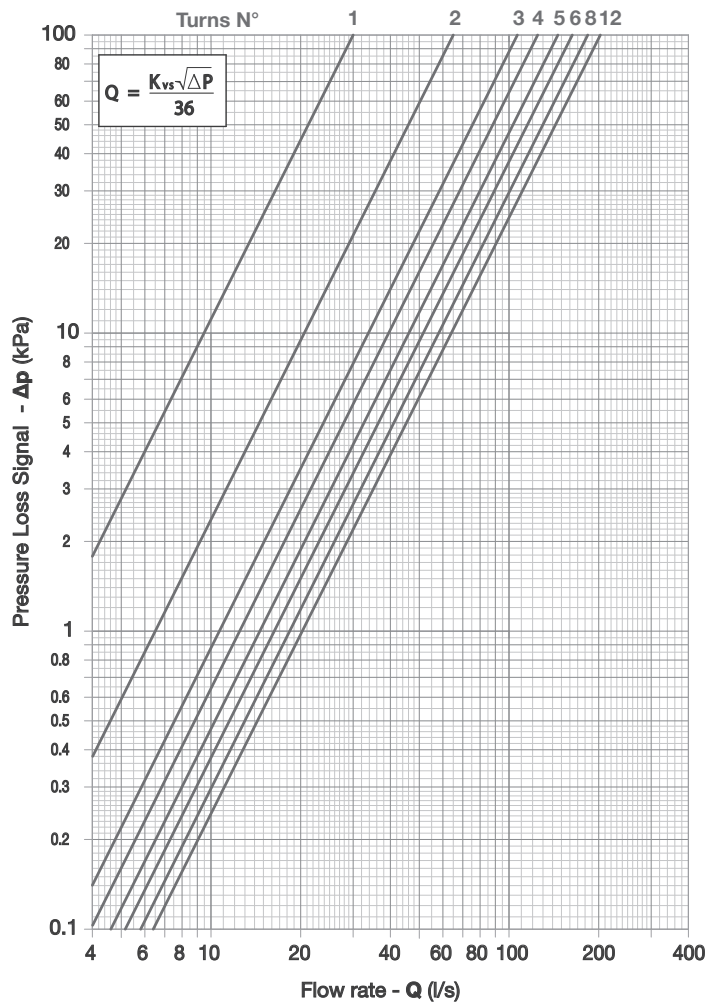
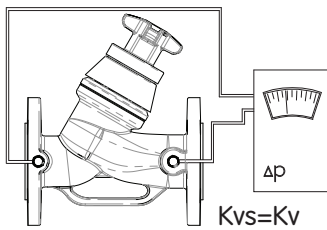

Kv-Kvs (Flow rate in m <sup>3</sup> /h @ 1 bar pressure drop)										
Full turn	Tenths of turn									
	0.0	0.1	0.2	0.3	0.4	0.5	0.6	0.7	0.8	0.9
1	108.67	121.41	134.14	146.88	159.61	172.35	185.09	197.82	210.56	223.29
2	236.03	250.04	264.06	278.07	292.09	306.10	320.11	334.13	348.14	362.16
3	376.17	383.95	391.73	399.51	407.29	415.07	422.85	430.63	438.14	446.19
4	453.97	461.07	468.16	475.26	482.35	489.45	496.55	503.64	510.74	517.83
5	524.93	531.05	537.16	543.28	549.39	555.51	561.63	567.74	573.86	579.97
6	524.93	531.05	537.16	543.28	549.39	555.51	561.63	567.74	573.86	579.97
7	586.09	589.05	592.02	594.98	597.94	600.91	603.87	606.83	609.79	612.76
8	660.02	662.51	664.99	667.48	669.97	672.46	674.94	677.43	679.92	682.40
9	684.89	685.34	385.80	686.20	686.70	687.16	687.61	688.06	688.51	688.97
10	689.42	692.16	694.90	697.64	700.38	703.13	705.87	708.61	711.35	714.09
11	716.83	717.63	718.43	719.22	720.22	720.82	721.62	722.42	723.21	724.01
12	724.81									
13										
14										

**TECHNICAL DATA SHEET**

**Kv Values - DN 250**

Cim 3739B  
 Cim 3739BDP  
 Cim 3739G

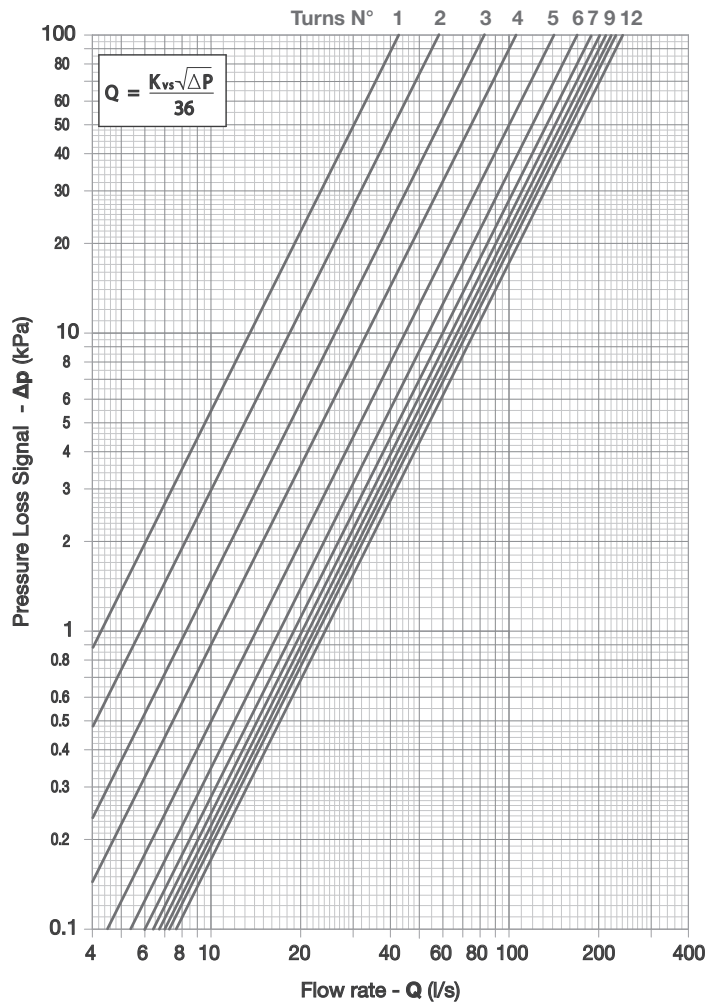
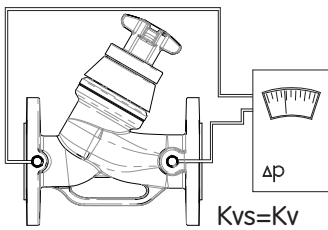

Kv-Kvs (Flow rate in m <sup>3</sup> /h @ 1 bar pressure drop)										
Full turn	Tenths of turn									
	0.0	0.1	0.2	0.3	0.4	0.5	0.6	0.7	0.8	0.9
1	153.99	159.48	164.98	170.47	175.97	181.46	186.95	192.45	197.94	203.44
2	208.93	217.89	226.85	235.81	244.77	253.74	262.70	271.66	280.62	289.58
3	298.54	306.27	314.00	321.73	329.46	337.19	344.92	352.65	360.38	368.11
4	375.84	389.84	403.84	417.83	431.83	445.83	459.83	473.83	487.82	501.82
5	515.82	525.54	535.27	544.99	554.72	564.44	574.16	583.89	593.61	603.34
6	613.06	620.54	628.02	635.50	642.98	650.46	657.94	665.42	672.90	680.38
7	687.86	691.94	696.01	700.09	704.16	708.24	712.32	716.39	720.47	724.54
8	728.62	732.94	737.25	741.57	745.89	750.21	754.52	758.83	763.14	767.45
9	771.79	774.04	776.30	778.55	780.81	783.06	785.31	787.57	789.82	792.08
10	794.33	796.65	798.97	801.29	803.61	805.93	808.24	810.56	812.88	815.20
11	817.52	822.26	827.21	832.05	836.90	841.74	846.58	851.43	856.27	861.12
12	865.96									
13										
14										

**TECHNICAL DATA SHEET**

**Kv Values - DN 300**

Cim 3739B  
 Cim 3739BDP  
 Cim 3739G

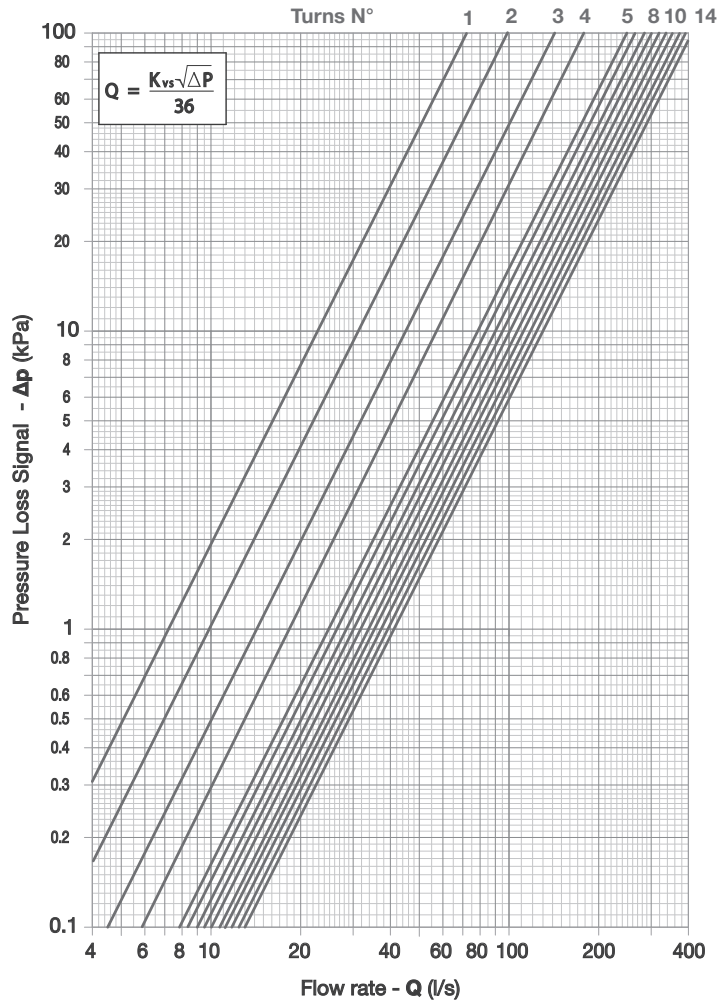
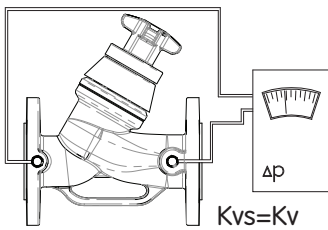

Kv-Kvs (Flow rate in m <sup>3</sup> /h @ 1 bar pressure drop)										
Full turn	Tenths of turn									
	0.0	0.1	0.2	0.3	0.4	0.5	0.6	0.7	0.8	0.9
1	256.83	266.98	277.12	287.27	297.41	307.56	317.70	327.85	337.99	348.14
2	358.28	373.84	389.40	404.95	420.51	436.07	451.63	467.19	482.74	498.30
3	513.86	528.43	543.01	557.58	572.15	586.73	601.30	615.87	630.44	645.02
4	659.59	683.13	706.67	730.20	753.74	777.28	800.82	824.36	847.89	871.43
5	894.97	901.63	908.29	914.94	921.60	928.26	934.92	941.58	948.23	954.89
6	961.55	968.21	974.87	981.52	988.18	994.84	1001.50	1008.16	1014.81	1021.47
7	1028.13	1034.00	1039.86	1045.73	1051.59	1057.46	1063.33	1069.19	1075.06	1080.92
8	1086.79	1092.99	1099.19	1105.39	1111.59	1117.79	1123.99	1130.19	1136.39	1142.59
9	1148.79	1155.34	1161.90	1168.45	1175.01	1181.56	1188.11	1194.67	1201.22	1207.78
10	1214.33	1221.26	1228.19	1235.11	1242.04	1248.97	1255.90	1262.83	1269.75	1276.68
11	1283.61	1289.44	1295.26	1301.09	1306.91	1312.74	1318.57	1324.39	1330.22	1336.04
12	1341.87	1347.18	1352.50	1357.81	1363.13	1368.44	1373.75	1379.07	1384.38	1389.70
13	1395.01	1402.97	1410.93	1418.89	1426.85	1434.81	1442.76	1450.72	1458.68	1466.64
14	1474.60									



TECHNICAL DATA SHEET

Main dimensions:

Cim 3739B  
Cim 3739BDP

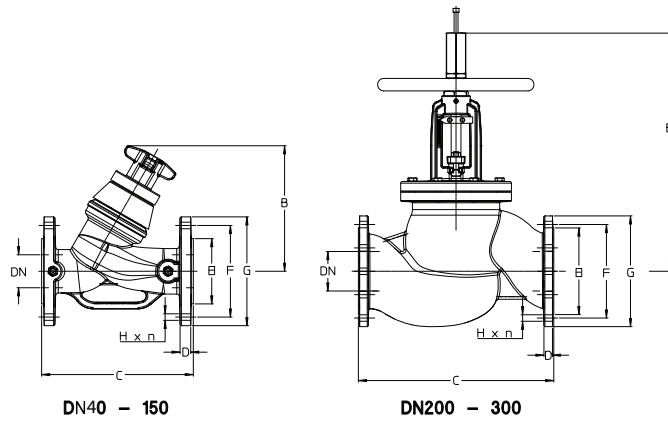

DN	40	50	65	80	100	125	150	200	250	300
Kgs.	8.2	11.6	15.6	19.8	34.8	52.4	78.6	173	254	350
B	178	190	215	225	334	369	403	732	740	849
C	200	230	290	310	350	400	403	600	730	850
D	14	16	17	19	21	22	21	26	29	28
E	84	99	118	132	156	178	211	266	320	370
F	110	125	145	160	180	210	240	295	355	410
G	150	165	185	200	220	250	285	340	405	460
H	19	19	19	19	19	19	23	23	28	28
n	4	4	4	8	8	8	8	12	12	12

Main dimensions:

Cim 3739G

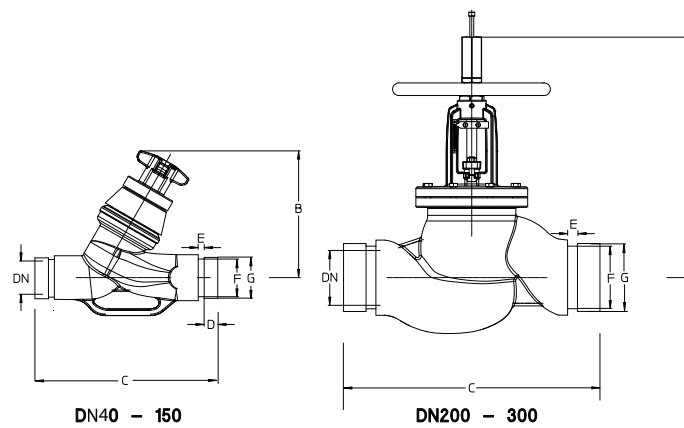

DN	40	50	65	65A	80	100	125	125A	150	150A	200	250	300
Kgs.	7	10	15	15	20	31	40	40	64	64	134	202	267
B	178	190	214	214	225	334	388	388	403	403	825	900	946
C	200	230	290	290	310	350	400	400	400	480	600	730	850
D	16	16	16	16	16	16	16	16	16	16	19	19	19
E	7	9	9	9	9	9	9	9	9	9	12	12	12
F	45	57	72	69	85	110	135	137	164	161	214	268	318
G	48	60	76	73	89	114	140	141	168	165	219	273	324

## TECHNICAL DATA SHEET

### **Maintenance:**

As a rule, the balancing valve does not need any maintenance. In case of replacement or need of disassembling of some components of the valve, make sure that the installation is not under service or pressure.

TECHNICAL DATA SHEET

cav. uff. **GIACOMO CIMBERIO**  
**s.p.a.**

28017 San Maurizio d'Opaglio (NO) - Italy - Via Torchio, 57 - C.P. 106  
Tel. +39 0322 923001 - Fax: +39 0322 967216 / 967755  
skype: cimberiosk1, cimberiosk2

info@cimberio.it

**www.cimberio.com**

© Copyright - Cav. Uff. GIACOMO CIMBERIO S.p.A. - All rights reserved. Tutti i diritti riservati.



IMR 562637



FM 01820



SA 551551



EMS 551553



OHS 551552



ENMS 577357